

PETKIT

USER MANUAL

AIRSALON MAX

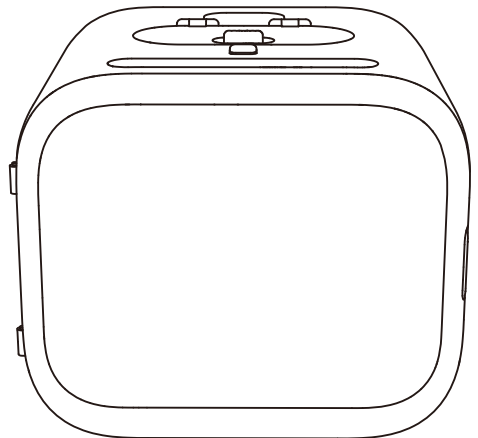

Please read the User Manual carefully before using the product and keep it properly.

V1.0-2023.01

CONTENT

Product list	3
Device activation	5
Product use	9
App function	12
Cleaning & maintenance	14
Basic specifications	20
A message to our valued customers	20
Instructions for safe use	21
Precautions	22

01 PRODUCT LIST

Front view

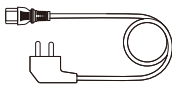
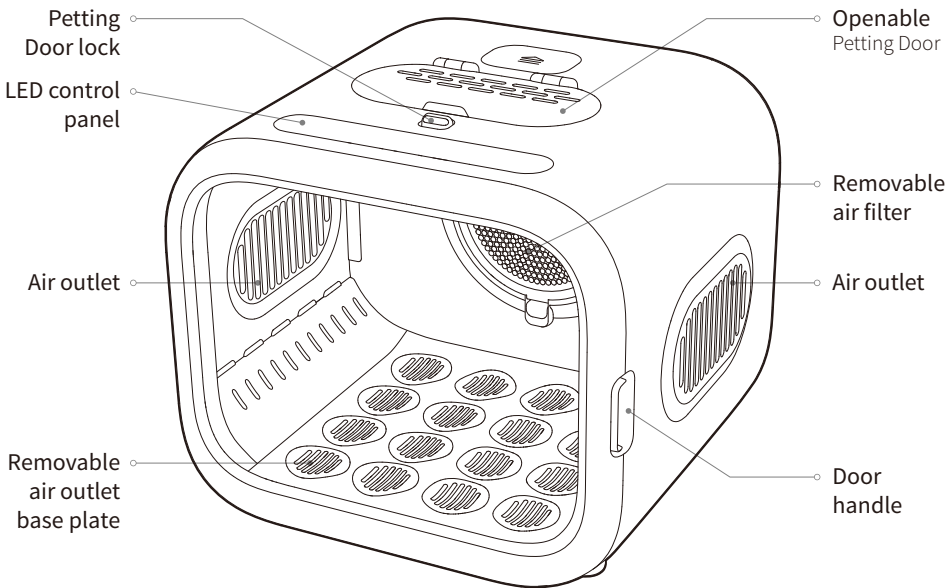

Power cord *1

*Note: In order to provide a better user experience, we will be implementing periodic product enhancements. Product images shown for illustration purpose only. Actual product may vary from the image shown. For any discrepancies, please refer to the actual product.

Back view

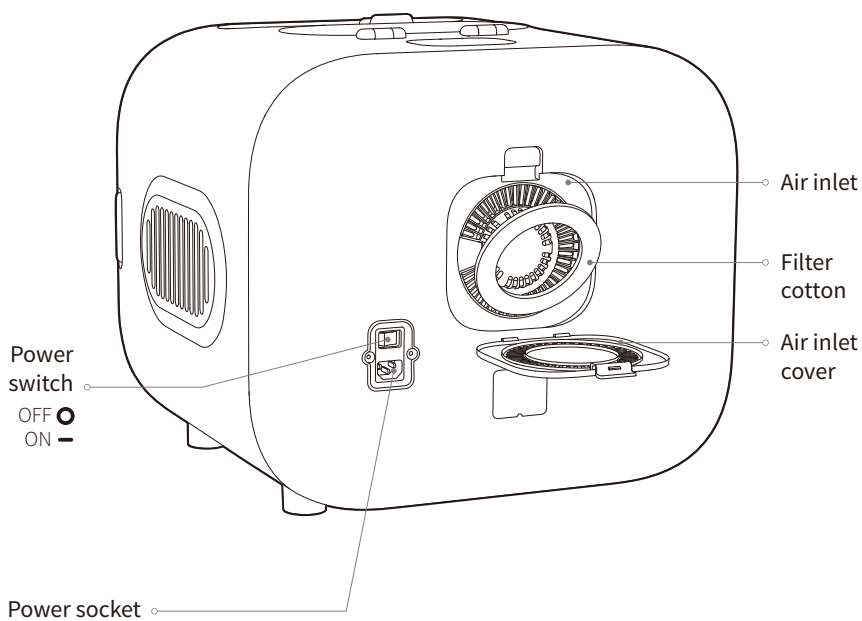

02 DEVICE ACTIVATION

1. Connect power supply

- ① Plug the power cord into the power socket on the back of the device.
- ② Then insert the power plug into an indoor power socket;
- ③ Turn on the power switch on the back of the device. (— ON ; ○ OFF)

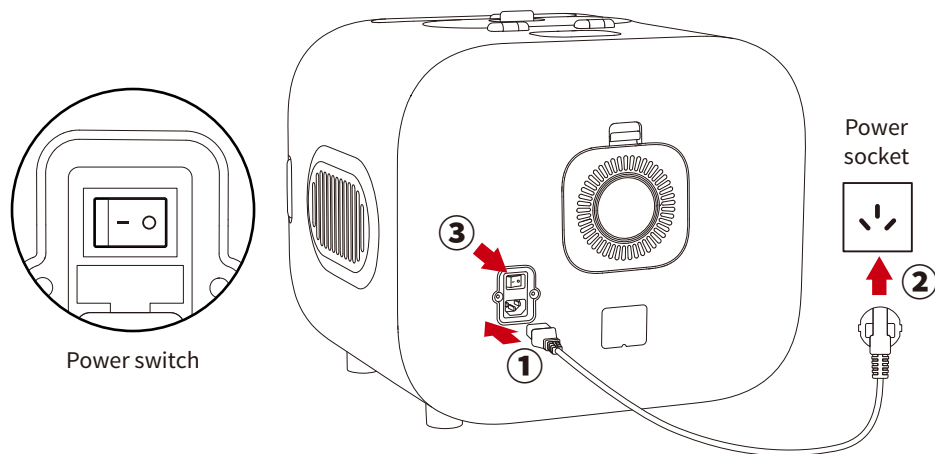

2. Download the PETKIT Pet App

In order to ensure pet safety and correct product use, the AIRSALON MAX is inactivated when it leaves the factory. After turning on the device the screen will flash continuously, the PETKIT App must be downloaded and installed, and after completing a series of safety operation instructions the device can be bound. After activation, use the device according to the product instructions

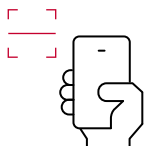

Download PETKIT App from the Apple App Store or Android App Market



3. Add Device

- ① Download the PETKIT App and enter the home page
- ② Click “+” located in the top right corner of the page
- ③ Select "PETKIT AIRSALON MAX"

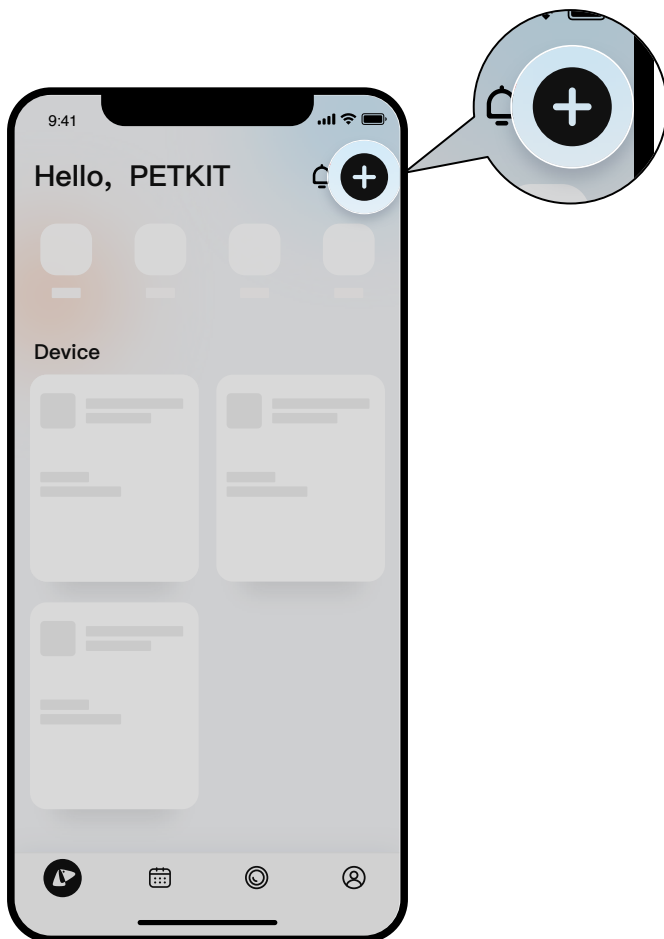

*Note: In order to provide better products, we will regularly update and improve the App. If there are differences with APP pictures, please refer to the actual product.

4. Start connection

- ① Scan and click "PETKIT AIRSALON MAX", or manually select "PETKIT AIRSALON MAX" from the list and start connection.
- ② The App will attempt to connect to the device, please wait until "Connected" is displayed.

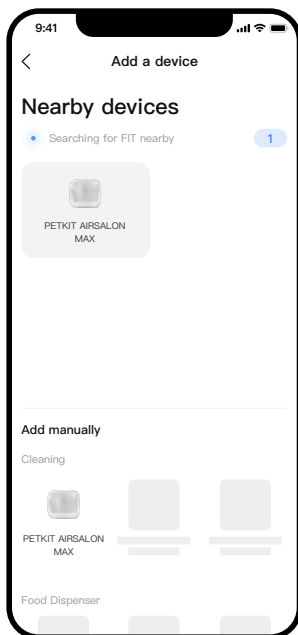

*Note: In order to provide better products, we will regularly update and improve the App. If there are differences with APP pictures, please refer to the actual product.

5. Activate device

In order to ensure pet safety and correct product use, after the first successful device connection, carefully read product use instructions and activate, after successful activation, use this product according to the product instruction.

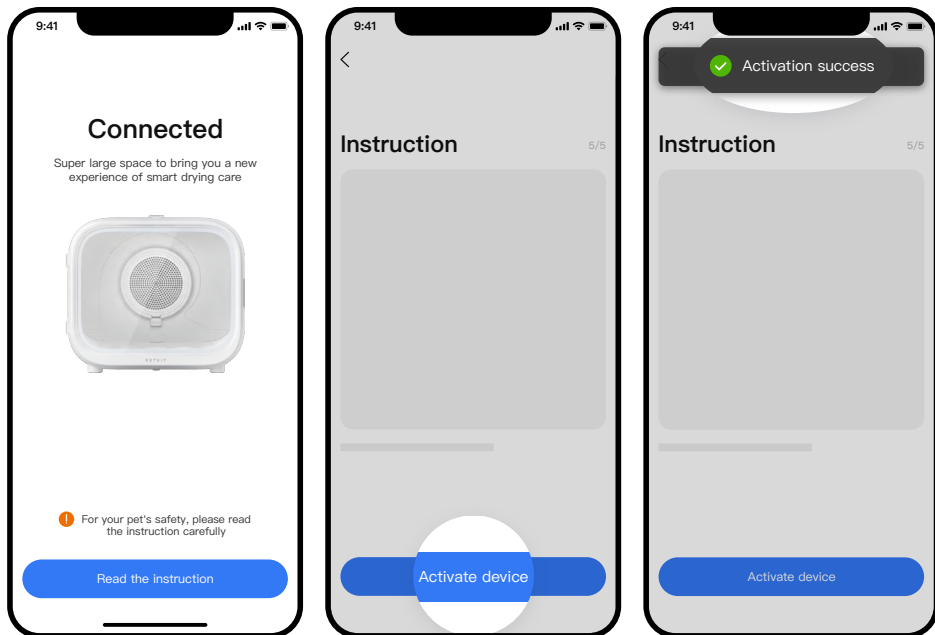

*Note: In order to provide better products, we will regularly update and improve the App. If there are differences with APP pictures, please refer to the actual product.

03 PRODUCT USE

1. LED Control Panel

Set the temperature, wind and time according to the actual situation.

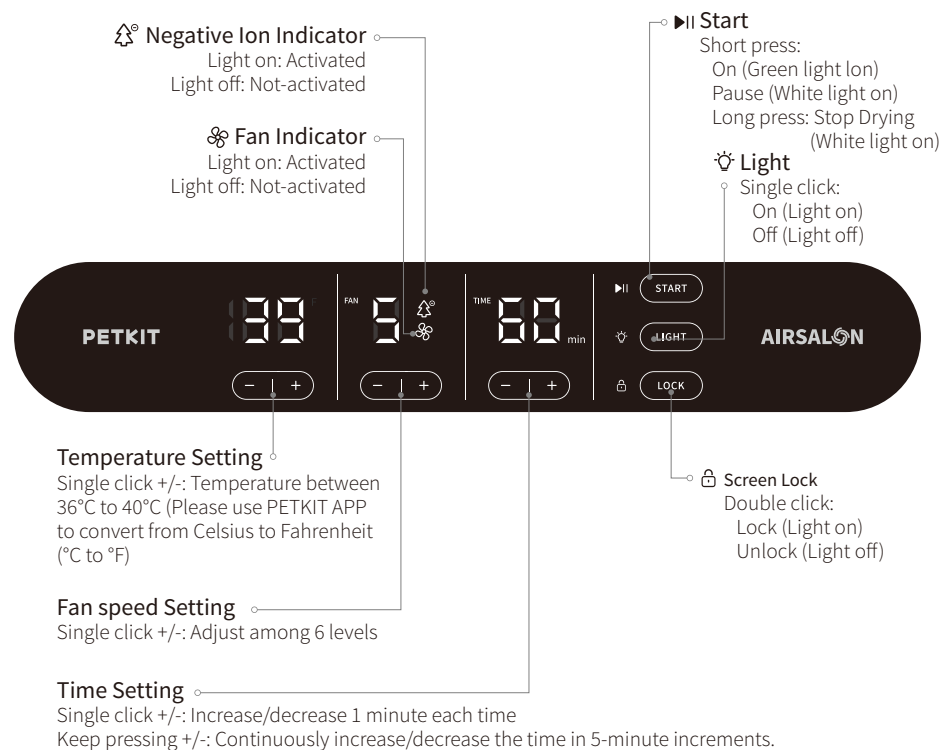

2. Drying Temperature Recommendation

Recommended temperature	Applicable condition
36°C~38°C	Room temperature above 24°C
38°C~40°C	Room temperature below 24°C

* Above is the recommended temperature. Please select the temperature according to the actual situation.

* When drying short nosed pets (Garfield, Pug, etc.), pay attention to lowering the temperature.

3. Drying pet with towel

Use a towel to dry your pet's hair. (Wipe as much moisture off the hair, this will greatly reduce drying time)

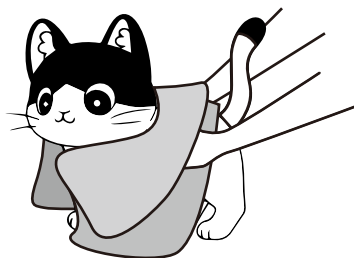

4. Drying

① Place the pet into the drying box and close the door.

(Note: Do not put towels, cushions, etc. into the device, so as not to block the air inlet.)



- ② If your pet is uncomfortable, the openable petting door can be opened to stroke and comfort your pet.

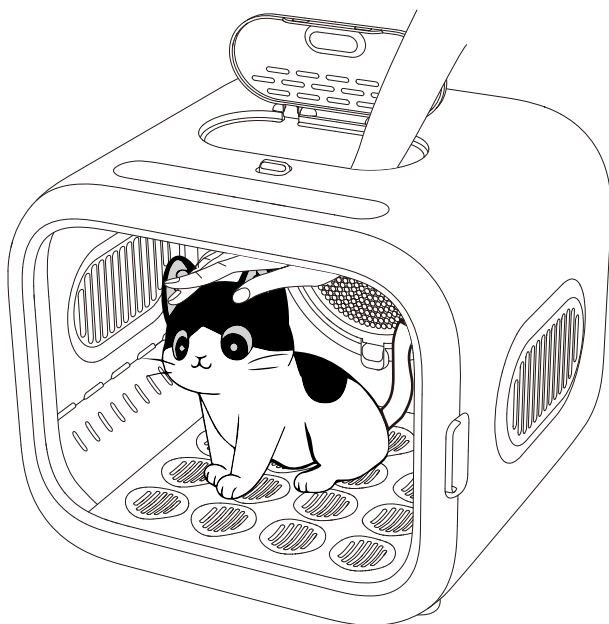

*** Please accompany and keep close watch of your pet, until the device emits a “dee, dee” sounds which shows the drying is complete.**

(for pets with long hair, it is recommended to brush their hair during drying)

04 App FUNCTION

1. Check device status

Click the AIRSALON MAX from the device list on the home page, enter to view the device working status, the remaining drying time, the temperature and humidity inside; The temperature, wind strength and duration can be adjusted on the home page.

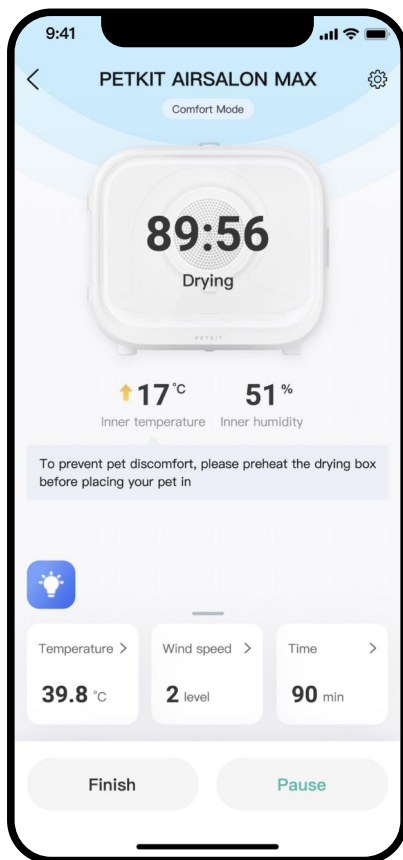

*Note: In order to provide better products, we will regularly update and improve the App. If there are differences with APP pictures, please refer to the actual product.

2. Default drying mode

The AIRSALON MAX has three modes: Comfort mode, Normal mode and Fast mode

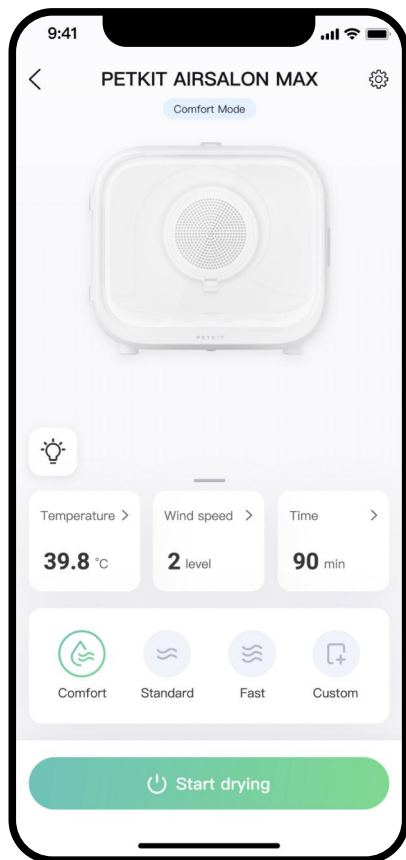

3. Custom drying mode

You can adjust the temperature, wind strength and duration according to your pets drying needs, and then save these parameters as a new mode

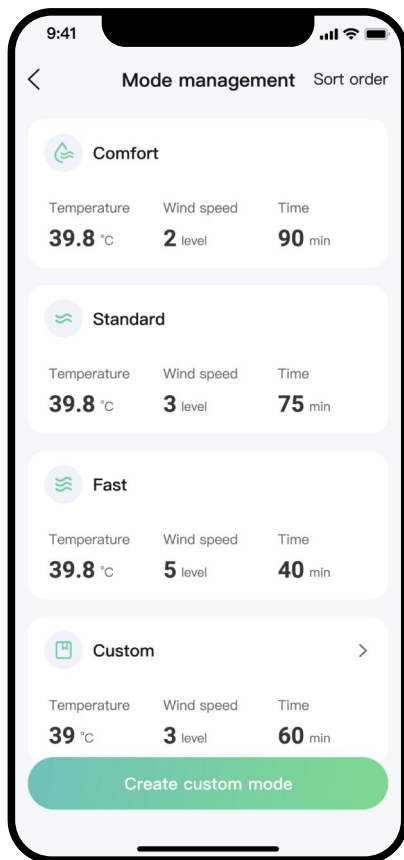

*Note: In order to provide better products, we will regularly update and improve the App. If there are differences with APP pictures, please refer to the actual product.

05 CLEANING & MAINTENANCE

It is recommended to regularly remove the inner wall of the device, the removeable air outlet base plate and the air inlet filter plate for cleaning and wiping after drying.

1. DISMANTLING PARTS

① Remove the air inlet filter plate and filter screen:

Step 1: Use a screwdriver to unscrew the screw on the handle of the air intake filter plate.

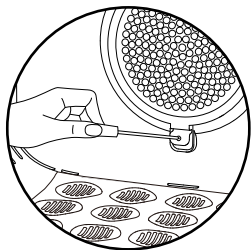

Second step, use your fingers to buckle the bottom of the filter plate (as shown in the picture), pull out the air inlet filter plate while lifting it upwards.

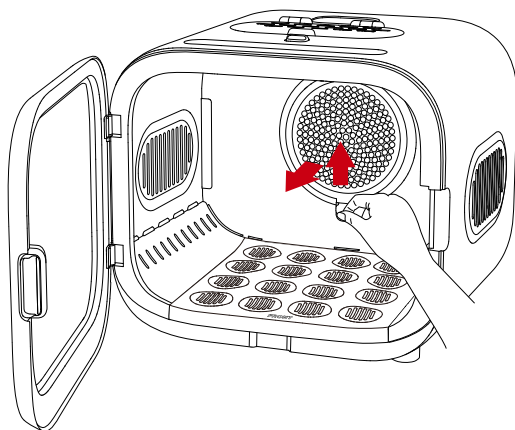

Third step is to pull out the filter screen with your fingers from the back of the air intake filter plate.

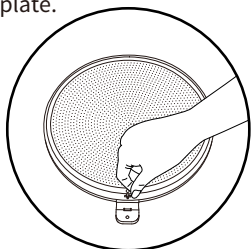

② Remove the air outlet bottom plate:

Put your finger on the grip position under the removeable air outlet base plate and lift it up (as shown in the picture),the air outlet base plate can be removed.

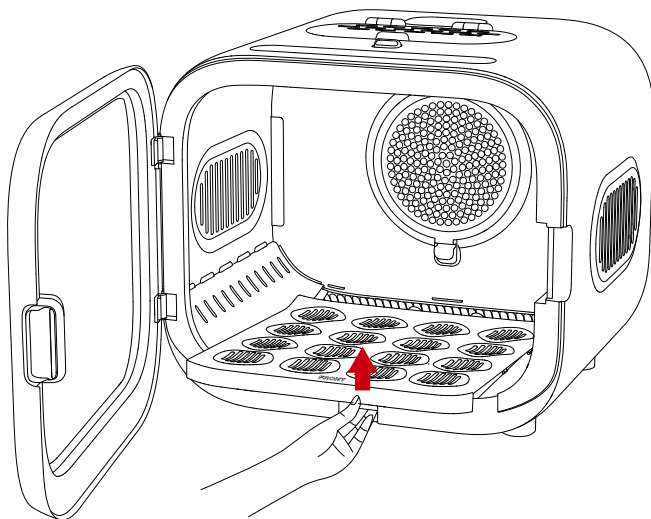

③ Remove the air inlet cover and filter cotton:

Use your fingers to pinch the handle on the top of the air inlet cover (as shown in the picture), pull out the air inlet cover while pressing down; remove the filter cotton.

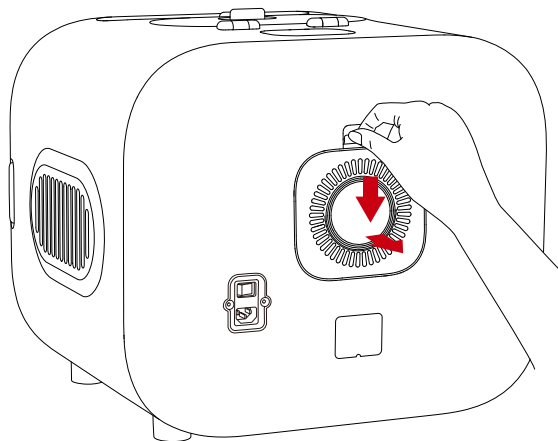

2. Cleaning parts

Please clean the pet hair from the filter cotton, air inlet cover, filter screen, air inlet filter plate, air outlet bottom plate, etc. Wash and dry.

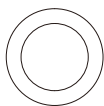

Filter cotton

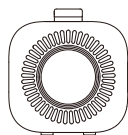

Air inlet cover

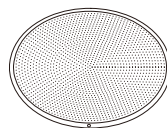

Filter screen

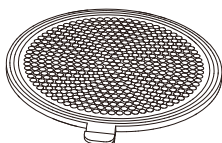

Air inlet filter plate

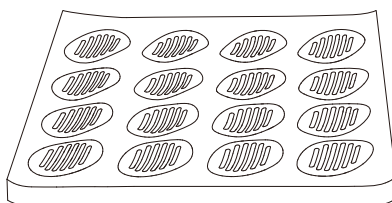

Air outlet base plate

3. Wiping the device

Please use a dry cloth to wipe the air inlet, wind inlet, air outlet, the inside of the main unit, sensor, button and other areas.

* The sensor cannot get wet

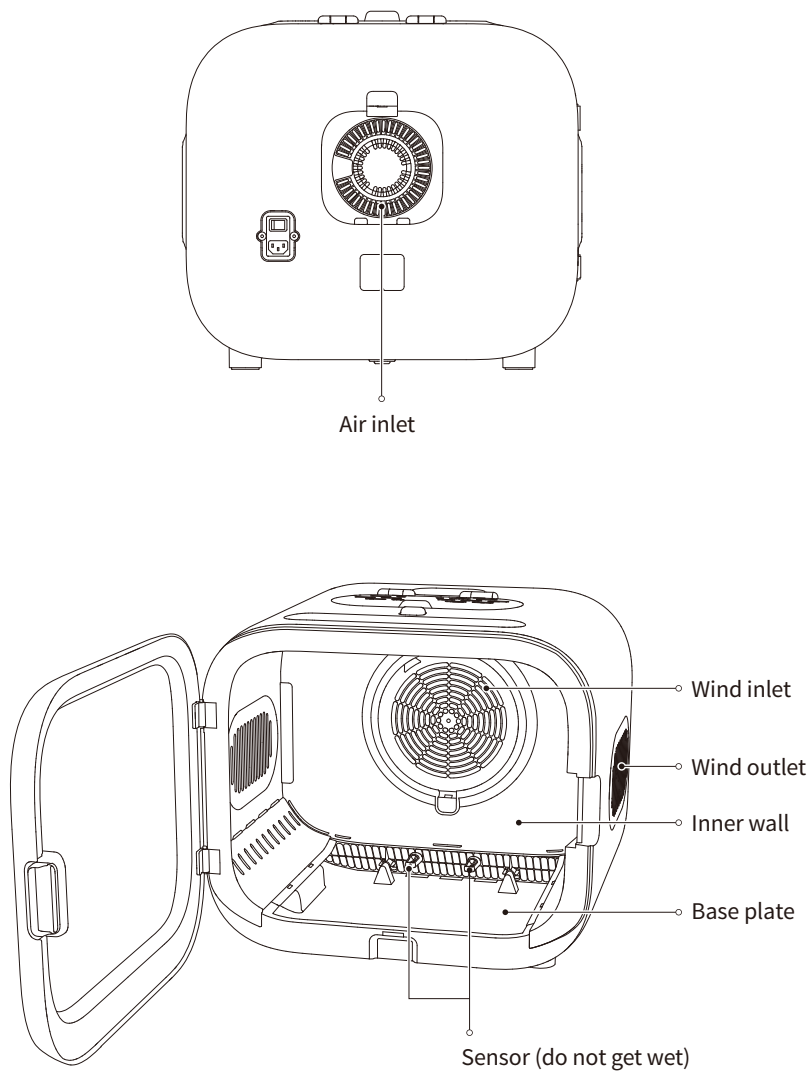

4. Parts installation

① Install the air inlet cover and filter cotton: Put the filter cotton into the air inlet groove (**filter cotton needs to be kept dry when putting back**), then put the two protrusions under the air inlet cover, align the two slots **a** and **b** on the drying box and insert them (as shown in the picture), press the handle of the air inlet cover until hear a "snap" sound to confirm the installation.

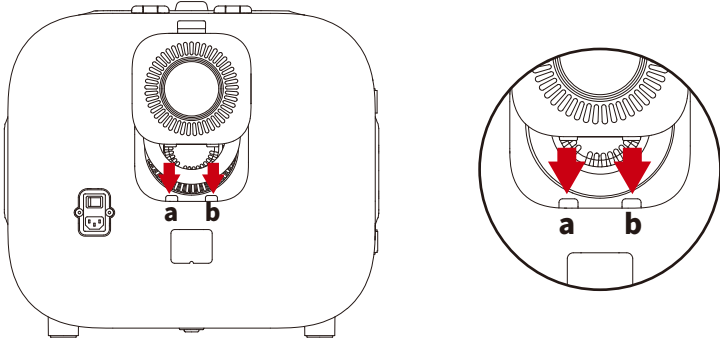

② Install the air outlet base plate: Put the front of the air outlet base plate forward (with **FRONT** text facing forward) Align the bottom of the **e**, **f**, and **g** points on the inner wall of the drying box, and secure tightly.

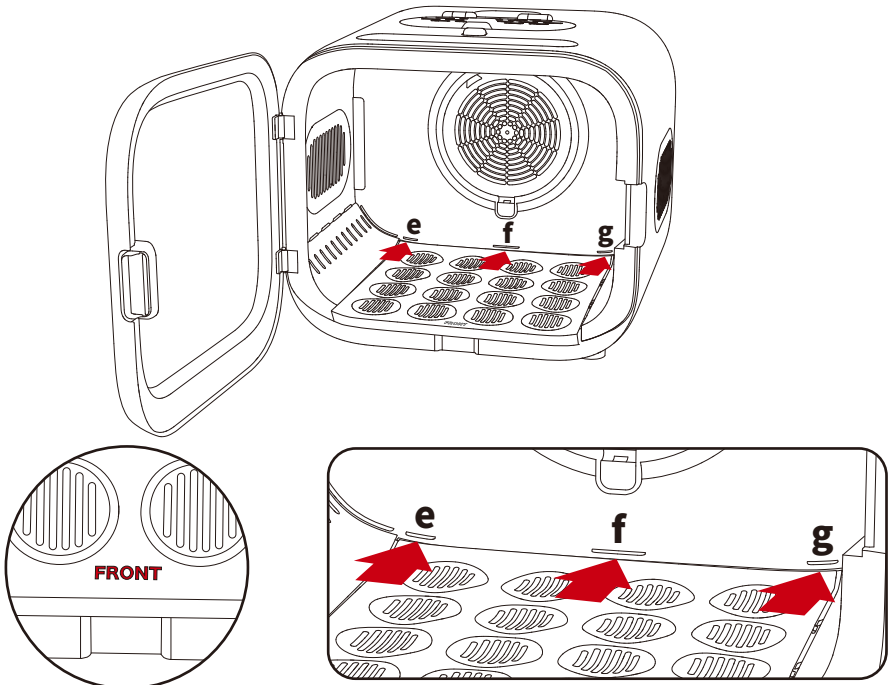

③ Install the filter screen and air inlet filter plate:

First step, install the filter screen on the back of the air inlet filter plate and press with hand, make sure that the cylinders on both sides are embedded in the round holes;

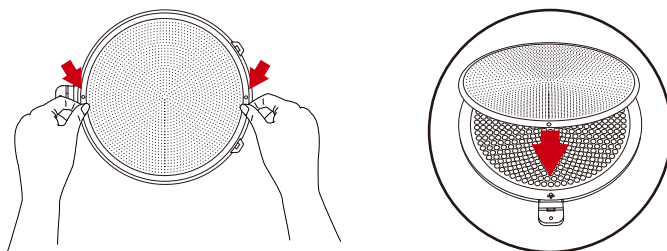

Second step, place the two protrusions above the air inlet filter plate, align the two slots **c** and **d** on the air outlet (as shown in the picture), press the handle of the air inlet filter plate until a "snap" sound is heard to confirm the installation;

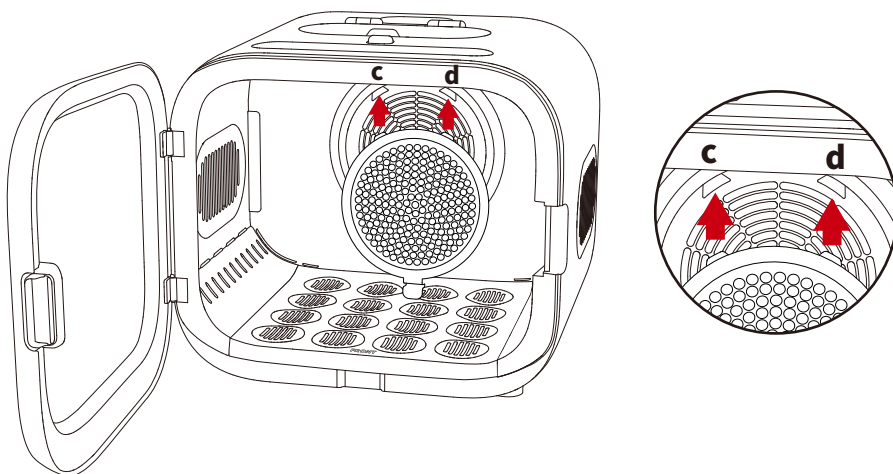

Third step, use a screwdriver to tighten the air inlet filter plate screws.

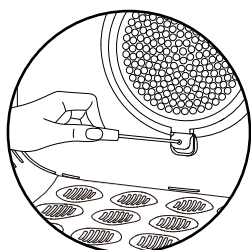

06 BASIC SPECIFICATIONS

Product name	PETKIT AIRSALON MAX
Product model	PD10
Product size	500 *473 *447mm
Scope of application	cats and small dogs aged 6 months and above
Product material	ABS, Tempered Glass
Product weight	about 9.7kg
Wireless connection	Bluetooth

07 A MESSAGE TO OUR VALUED CUSTOMERS

- Thank you for purchasing PETKIT AIRSALON MAX Smart Pet Dryer. We at PETKIT have done our best to make life easier for you and your pets with technology.
- Please carefully read the User Manual before using the product. By setting up and using this product, you are acknowledged that you have already read and accepted the safety guidelines listed below.
- We are not liable and will not accept responsibility for any accidents or injuries that result from improper use of this product.
- PETKIT reserves the rights of interpretation and revision.

08 INSTRUCTIONS FOR SAFE USE

* Failure to follow the safety guides outlined below can result in product malfunction or other unforeseen mishaps.

- Pet owner must be present when the pet is using this product.
- This equipment is strictly for indoor use in a dry environment. Do not use it on wet ground.
- After each drying, please clean the hair in the dryer and the air inlet immediately, and power off when cleaning.
- Do not place towels, mats and other items in the equipment to avoid blocking the air outlet and causing abnormal temperature or fan speed.
- Please place the equipment on a hard and flat horizontal surface, and do not place it on a soft and uneven object to prevent the equipment from falling.
- This equipment is only applicable to pet cats and small dogs 6 months old and above.
- Minors are prohibited from using this device.
- If the pet has special circumstances caused by its own reasons, such as being too old, having difficulty moving, suffering from physiological diseases, etc., please consult a professional veterinarian and use this equipment under guidance.
- In case of abnormal heating or abnormal internal noise of the equipment, please do not disassemble the equipment without permission. Be sure to repair it under the guidance of professional personnel to avoid various accidental injury.
- When using this device, if the pet feels uncomfortable, it can be comforted by pushing the Cat Patting Window on the top or adjust the wind force to reduce irritation. If the pet still feels uncomfortable, please stop use immediately.
- When the pet stays in the equipment, do not move the equipment to prevent the pet from falling.
- Although the device is in low voltage mode, please use it correctly in order to avoid electricity leakage caused by pets biting wires.
- For prolonged storage, please switch off the power first and then unplug the power cord.
- Please do not place it in direct sunlight and keep it away from ignition sources.
- Do not soak this product in water.
- It is prohibited to stack articles on the top of the equipment to prevent affecting the normal operation.
- Please use the produced power cord, otherwise it will damage the equipment or cause potential safety hazards.
- Please reserve 10cm space when placing the equipment beside the wall.
- The product must be used below the altitude of 2000 meters.
- If you encounter any problems while using this product, please contact us immediately.

09 PRECAUTIONS

- 1. Please ensure that the mobile phone is within 3 meters of the device when performing all App settings. The device will change settings according to App, when there is a "beep" sound, the setting is successful.**
- 2. The parameters adjusted when the device is in operation will not be synchronized when the device is started next time. Each time the device starts drying, it will automatically use the parameters set before the previous drying. If a set mode or parameters are to be used, please set the parameters before the device starts drying.**
- 3. After drying completed, if the AIRSALON MAX is not to be used again, please turn off the power switch on the back.**